

SECTION VIEW

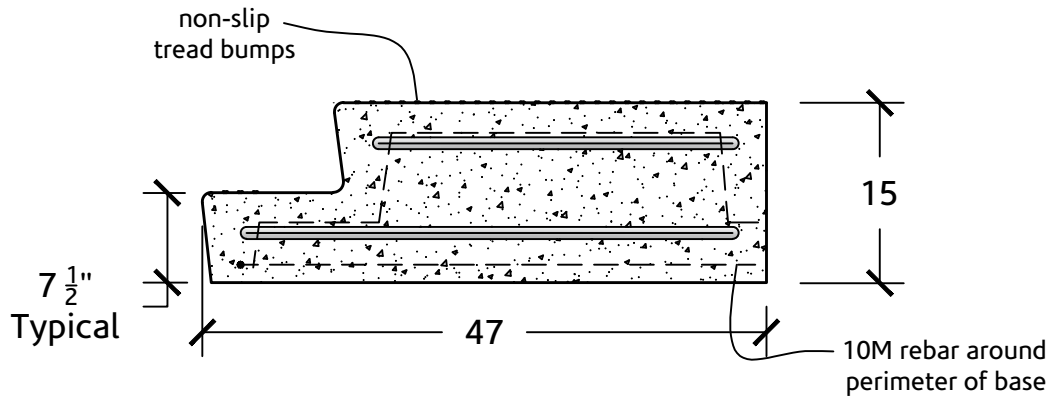

ELEVATION VIEW

NOTES:

1. AVAILABLE IN 3', 4', 5' & 6' WIDTHS



**TRADITIONAL STEP
WITH 36" PORCH**

SP36-2

ED'S CONCRETE PRODUCTS
1266 ERIE STREET
STRATFORD, ONTARIO
N4Z 0A1

1-877-265-6590
www.edskoncrete.com
info@edskoncrete.com

